

Compact Feeders
CONVEYING AND FEEDING
BULK MATERIAL TO PERFECTION



AViTEQ Vibrationstechnik

WE DRIVE YOUR SUCCESS

For more than 75 years, AViTEQ Vibrationstechnik GmbH has provided oscillating conveyor solutions to almost 350,000 projects. Our extensive experience and vibrating conveyor expertise is evident with our 125 AViTEQ employees worldwide, who are always to support our international client base.

UNSHAKEABLE QUALITY

AViTEQ systems and components feature comprehensive functionalities including: conveying, sorting and dosing, screening, classifying and dewatering, compacting and loosening, cooling and heating of various bulk materials. We provide extremely varied solutions and can apply these functionalities to suit small pills and coffee beans, as well as rocks and metal pieces weighing tons.

Every bulk material has its own special requirements and AViTEQ is most likely experienced with the process, as we have designed systems and components for more than 3,600 bulk materials to date. Endurance tests performed in our technical laboratories and numerous finite element calculations ensure the highest quality of our components and systems. Experience the unshakeable quality of AViTEQ.

AViTEQ worldwide



AViTEQ Product Portfolio

QUALIFIED PARTNER FOR SYSTEMS AND COMPONENTS

Systems

AViTEQ plans and realises vibration and process engineering solutions. Furthermore, a comprehensive offer including all-round service is made possible through AViTEQ and AEG.



Conveying technology



Screening technology

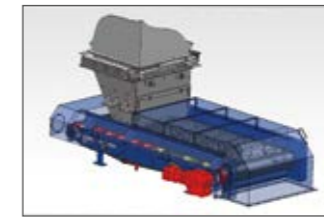

Weighing technology

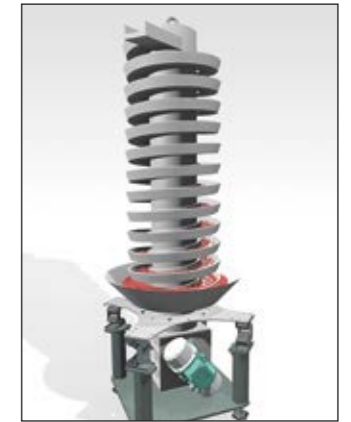

Process technology

Components

AViTEQ develops, builds and distributes drive components and control systems for vibrating conveyor systems. We also offer 24-hour replacement part support from the spare part warehouse, as well as various repair services (in-house or on-site).

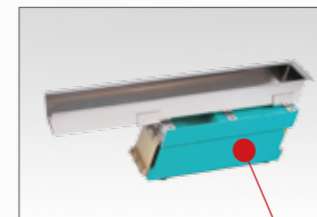

Compact feeder drives & compact feeders



Magnetic vibrators



Unbalanced motors



Parts conveyor

COMPACT FEEDERS

When it comes to discharging, feeding, conveying, sorting or dosing of fine-grained bulk materials, AViTEQ's compact feeders are true all-rounders. The drives are available in various sizes – from very small to very big – so they can be used in a wide range of systems. The modular construction of these compact feeders means that they offer ideal custom solutions.



Compact feeder technology from AViTEQ

QUALITY MADE IN GERMANY

The greatest strength of AViTEQ compact feeders is their modular construction. This allows them to be tailored for specific applications. As well as conveying goods, AViTEQ compact feeders can also be used for screening, spreading, sorting or weighing. The materials used are chosen to suit the conveyed goods and if desired, it is possible to use the controllers to fully automate the process.

This gives customers complete freedom of choice. They have quick, easy access to standard solutions but they can also take advantage of customised solutions that are tailored for their specific applications.



4 HOPPER

- In a conical, wedge or pyramid shape
- Optional gate
- Optional level indication

5 WEIGHING (LOSS-IN-WEIGHT SYSTEM)

- As standard or replacement components (weighing cell, weighing platform, weighing terminal)
- Customer-specific programming
- Optional: Housing design

6 STAND/ENCLOSURE

- Adjustable
- Can be moved on rollers
- Also available in stainless steel

3

CONTROLLERS

- Conveyor controllers, available as an open-frame version or in a version with housing
- Frequency controller available (optional)
- Weighing terminal available (optional)
- Complete control cabinet (optional)

2

CONVEYOR ATTACHMENTS

- Trough, tube, screen
- With or without covers
- Choose from a range of
 - linings
 - materials
 - inlets and outlets
 - seals
 - quick release systems
 - surface finishes (textures)

1

DRIVE

- Various sizes
- Versions with explosion protection
- Coatings available (options include PTFE, PFA, powder coating, etc.)
- Optional protection against tropical conditions



Design variants

MULTI-TALENTED DEVICES

AVITEQ compact feeders are two-mass vibration systems, which are tuned to be close to resonance frequency. The drive section contains the elements that generate the vibration. These include an electromagnet and the leaf spring packages. The conveyor attachment – also referred to as the working unit – is firmly attached to the drive and can be removed in a matter of moments. Thanks to their optimum design and tuning, the vibration of these systems is exceptionally regular.

A characteristic feature of AVITEQ compact feeders is their modular construction, which consists of a feeder drive and a conveyor attachment (trough, tube and conveyor rail). The Vibronic-S controller from AVITEQ is suitable for all drives. Using this controller and an integrated vibration distance adjuster, the flowrate can be freely adjusted within wide limits. AVITEQ compact feeders do not disturb the peace – they stand on rubber buffers, so the vibration only has an effect on the conveyed materials and is hardly noticeable in the surroundings.

Compact feeders from AVITEQ feature tailor-made conveying technology that is "Made in Germany". Multi-talented – for a multitude of applications.

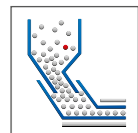

**DISCHARGING
FEEDING
CONVEYING**

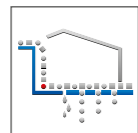

**SCREENING
CLASSIFYING
DEWATERING**

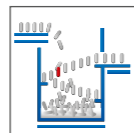

**SORTING
DOSING
METERING
STORING**

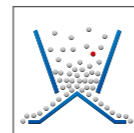

STREWING

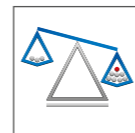

WEIGHING

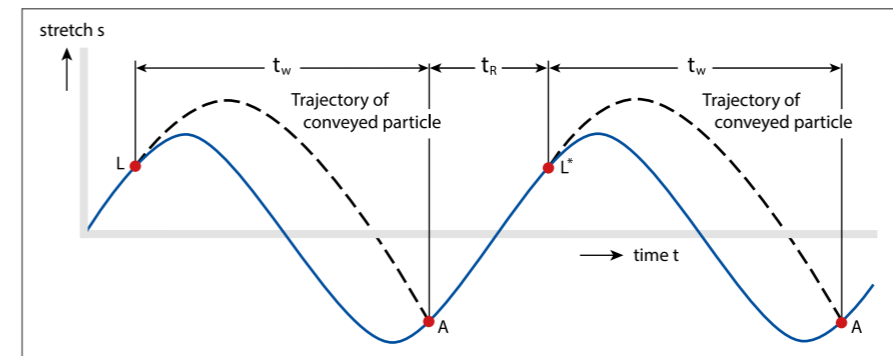

s = vibration amplitude
 L = release point
 L' = release point following L
 A = landing point
 t_w = jump time
 t_r = ride time of particle on the trough

THE CONVEYING PRINCIPLE

AVITEQ conveying equipment is based on a single conveying principle that has stood the test of time: a vibrating drive accelerates a trough-shaped steel structure in the jump direction, gently moving the bulk material forward in tiny jumps. The transport process

is determined by the frequency and amplitude of vibration, the angle of impact and the trough inclination. The drive system is selected on the basis of the conveying length, the performance, the material characteristics and any additional functions.

Compact feeders

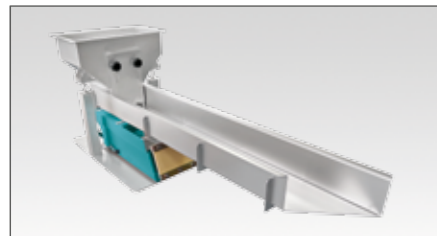

TROUGH CONVEYOR WITH HOPPER

- High capacity, precise dosing and a compact design
- Standard sizes in stock: available quickly and at low prices
- Trough and hopper can be adapted to meet custom requirements

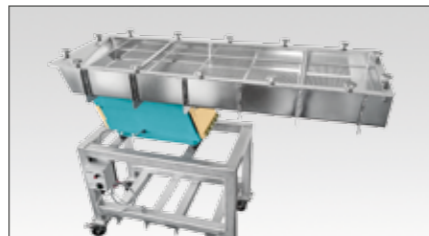

SCREENING TROUGH

- Individual screening solutions
- Easy to clean and replace
- Choose from a very wide range of materials and screen linings

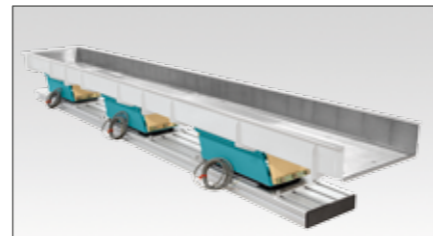

SUPPLY TROUGH CONVEYOR

- Trough conveyors for longer distances
- Custom length
- Multiple drives: Drives positioned behind one another
- The compact design means it can also be used in very narrow spaces

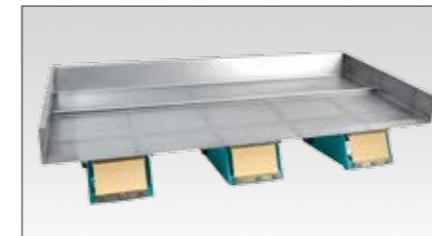

DISTRIBUTING CONVEYOR, STREWING FEEDER

- Distribution troughs can cover a width of up to 2m
- Multiple drives: Drives positioned side by side
- Speed can be freely adjusted
- Precise, single layer metering (perfect for sorting machines)

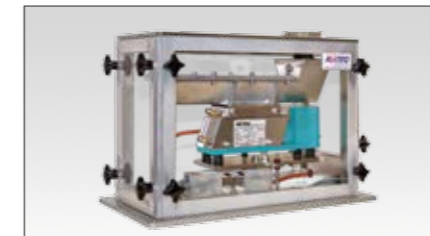

LOSS-IN-WEIGHT

- Very gentle weighing (volumetric and gravimetric)
- Extremely precise dosing
- High throughput capacity
- Low levels of shear and compression forces
- Troughs designed to have no dead space (quick and easy to clean)

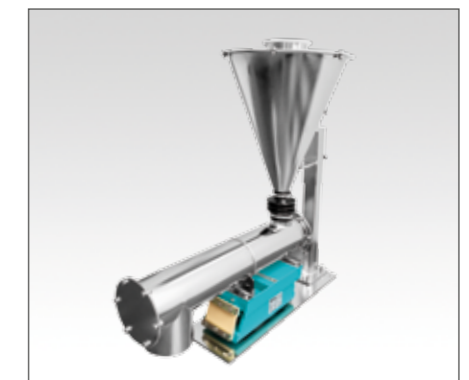

CONVEYOR TUBE WITH HOPPER

- Enclosed, dustproof design
- Inlet and outlets can be selected on an individual basis



AViTEQ compact feeder drives

SMALL BUT MIGHTY

The AViTEQ product portfolio contains two groups of compact feeder drives. The characteristics of these two groups are tailored for different applications:

The group with the KF 1, KF 6, KF 12 and KF 24 devices are mainly suitable for discharging and conveying bulk material. This includes applications such as distributing components in mixing plants. For this purpose, the compact feeder drive is equipped with a suitable tube or trough. The compact feeder devices KF 1, KF 6, KF 12 and KF 24 are type approved and can be used in potentially explosive atmospheres, in accordance with Directive 94/9/EC (ATEX).

The second group, with the devices KF 0.3, KF 0.5, KF 0.7 and KF 0.9, are mainly for use as drivers for rails for conveying ordered parts. A practical example is the transport or distribution route between a parts conveyor and a downstream machine. For this purpose, a conveyor trough that is optimised for the material being transported is mounted onto the drive. The compact feeder drives in CR-Design are uncoated, easy to clean and resistant to UV-light, alcohol and formalin. Furthermore, they are suitable for use in sterile areas.

TECHNICAL CHARACTERISTICS

Vibration frequency: 50, 100 Hz in a 50 Hz network
60, 120 Hz in a 60 Hz network

Capacity: from a few kg/h to more than 50 t/h

Working weight: 0.3 – 45 kg

Mains frequency: alternating current (50 or 60 Hz)

Mains voltage: 42, 110, 230, 400 V
(special voltages available on request)

Ambient temperature: -20 °C to +40 °C
(lower and higher temperatures possible)

Standard protection*: IP 55 to DIN EN 60529

Optional: tropic-proof insulation, special coating, stainless steel version, a range of coatings (on request)

* different protection with different types of drive

OUR SAFETY STANDARDS



UPPER SECTION (OPERATING SIDE) 1

Cast iron base plate for mounting the working unit

BENEFITS:

- Two-mass vibration system
- High levels of operational safety
- Long service life

MOUNTING HOLES 2

For attaching working units.

BENEFIT:

- High degree of flexibility – either to the top or to the front

3

SPRING PACKAGES

Made of plastic to ensure a long service life and maintain linear vibration motions

BENEFITS:

- No wear
- No maintenance costs
- Continuous operation with 100% performance

4

RUBBER BUFFER

Optimum vibration isolation.

BENEFITS:

- High rates of absorbency under load
- Very good vibration damping

LOWER SECTION (FREE SIDE) 7

Cast iron plate designed for heavy loads.

BENEFITS:

- Closed system for vibrations
- High levels of operational safety
- Long service life

6 ELECTROMAGNET

Split toroid core cast in electro-casting resin.

BENEFITS:

- High levels of operational safety in harsh environments
- Available for use in potentially explosive atmospheres
- Not susceptible to moisture or dust

5

CABLE ENTRY POINT

Overmoulded cable (length: 2.5 metres) with strain relief.

BENEFITS:

- Quick and easy to install
- High levels of operational safety
- Secure fit
- Voltages up to 1,000 V, no additional insulation required

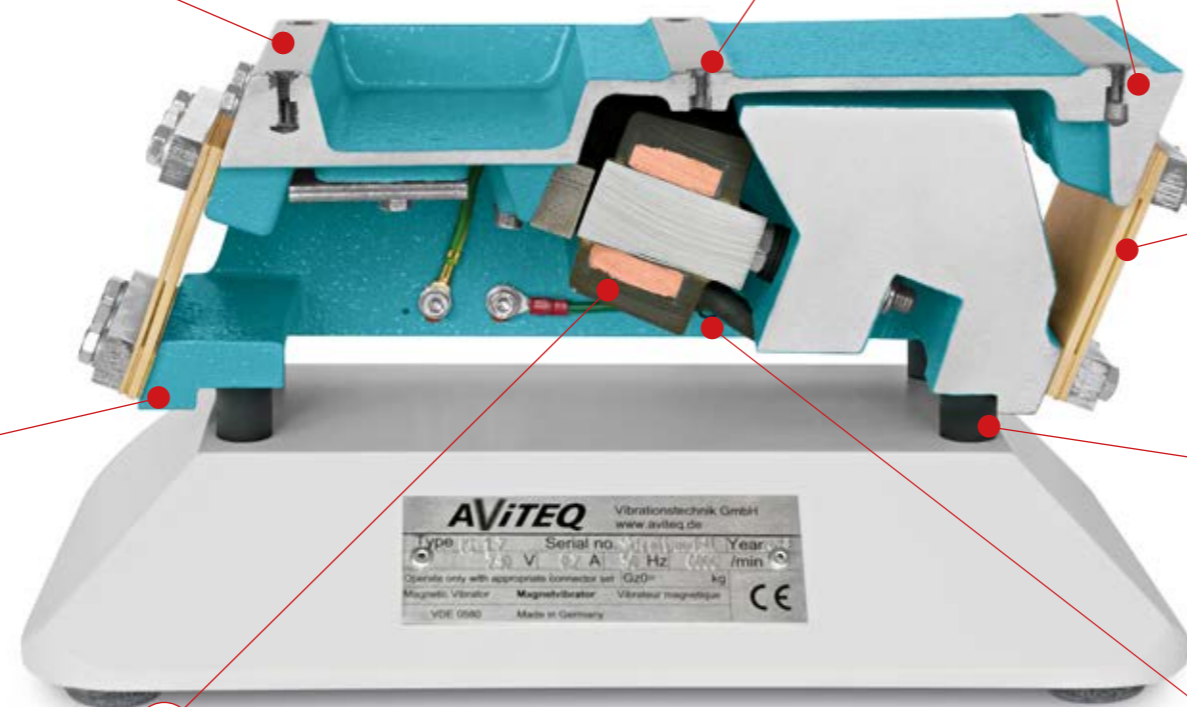

AViTEQ compact feeder drives

ROBUST, POWERFUL AND RESILIENT

COMPACT FEEDER DRIVES

Types: KF 1, KF 6, KF 12, KF 24

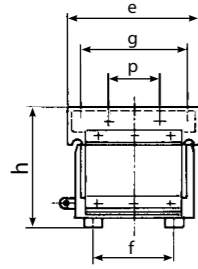

Types: KF 0.3, KF 0.5, KF 0.7, KF 0.9

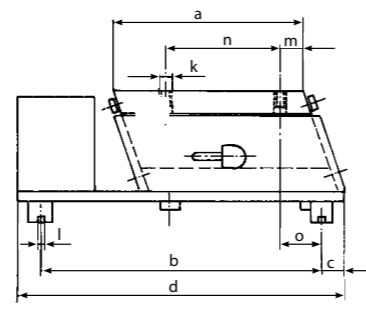
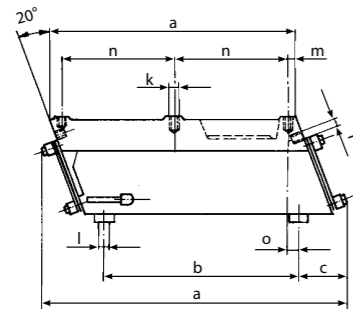
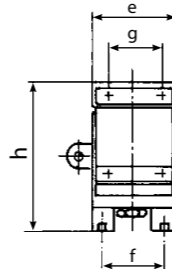

Type	Working units with ideal to maximum weight ¹⁾ [kg]	ATEX	max. length L [mm]	Weight without working unit [kg]	Vibrations/min in a 50 Hz network	Max. current draw at 230 V, 50 Hz [A]
KF 1	1.5 – 3.5	+	600	8.0	6,000	0.20
KF 6	3.0 – 7.0	+	1,000	20.0	3,000	0.85
KF 12	6.0 – 20.0	+	1,400	33.0	3,000	2.20
KF 24	18.0 – 45.0	+	1,800	93.0	3,000	3.75
KF 0.3	0.3 – 0.5	-	350	1.5	6,000	0.06
KF 0.5	0.5 – 0.8	-	450	2.8	6,000	0.07
KF 0.7	1.5 – 2.7	-	700	10.0	6,000	0.32
KF 0.9	3.0 – 5.5	-	950	18.0	3,000	1.20

1) Lower working weights available (on request)

ATEX conformity

SENSITIVE TO THE NEEDS OF SPECIAL AREAS

AViTEQ compact feeders are also available in versions with qualities that conform to the ATEX Directive.

Category	Device group 1		Device group 2					
	M1	M2	1	2	3			
Level of safety	Very high level of safety	High level of safety	Very high level of safety	High level of safety	Medium level of safety			
Zone classification	-	-	G (Gas) Zone 0	D (Dust)* Zone 20	G (Gas) Zone 1	D (Dust)* Zone 21	G (Gas) Zone 2	D (Dust)* Zone 22
Requirements for the manufacturer				The manufacturer must have a quality assurance system that is certified as conforming to ATEX. An EC type examination certificate from an external testing agency is required.		The manufacturer must present a declaration of conformity to demonstrate compliance with the directive.		

*Dust = Staub (Engl.)

Dimensions [mm]

Type	a	b	c	d	e	f	g	h	k	l	m	n	p	r
KF 1	247	200	45	305	123	70	100	107	M5	M4	7.5	110	40	M5
KF 6	340	270	65	425	163	100	140	145	M8	M6	10.0	155	60	M6
KF 12	415	345	70	515	203	140	180	164	M8	M6	10.0	190	80	M8
KF 24	524	430	90	670	305	200	250	240	M10	M8	13.0	240	150	M10
KF 0.3	90	140	10	160	35	25	25	65	M4	M4	15.0	55	-	-
KF 0.5	120	180	15	210	50	35	33	85	M5	M4	15.0	72	-	-
KF 0.7	180	290	15	320	75	60	55	110	M6	M4	15.0	120	-	-
KF 0.9	200	330	23	375	100	75	80	140	M8	M6	20.0	130	-	-

All values are in mm. Manufacturing tolerances are relative to the respective container. The value 'd' may vary depending on the working weight (leaf spring placement)



Compact feeders

VERSATILE ALL-ROUNDERS

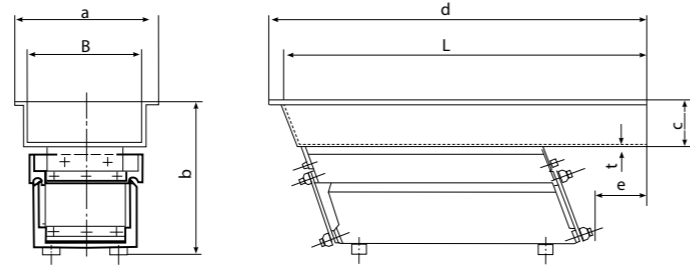

Type ¹⁾	L/W	Material ²⁾	Capacity ³⁾	Dimensions [mm]						Trough weight
				mm	m ³ /h	a	b	c	d	
KF 1 /	400/ 50	1.4301	0.8	80	155	40	415	75	1.0	0.60
	450/ 50	1.4301	0.7	80	155	40	465	125	1.5	0.95
	500/ 50	1.4301	0.7	80	155	40	515	175	1.0	0.75
	600/ 50	1.4301	0.7	80	155	40	615	275	1.5	1.25
	400/100	1.4301	2.2	130	175	60	415	70	1.5	1.70
	500/100	1.4301	2.1	130	175	60	515	170	1.5	1.90
KF 6 /	500/100	1.4301	3.0	130	210	60	515	65	1.5	1.90
	550/100	1.4301	3.0	130	210	60	565	115	1.5	2.10
	630/100	1.4301	2.8	130	210	60	645	195	1.5	2.30
	800/100	1.4301	2.6	130	210	60	815	365	1.5	2.70
	1,000/100	1.4301	2.5	130	210	60	1,015	460	1.5	3.20
	500/150	1.4301	4.4	190	210	60	520	65	1.5	2.40
	700/150	1.4301	4.4	190	210	60	720	265	1.5	2.90
	850/150	1.4301	4.2	190	210	60	870	415	1.5	3.40
	1,000/150	1.4301	4.0	190	210	60	1,020	550	1.5	4.00
	500/200	1.4301	5.8	240	210	60	520	65	1.5	2.80
KF 12 /	630/200	1.4301	5.6	240	210	60	650	180	1.5	3.40
	630/200	1.4301	9.7	240	270	100	650	80	2.0	4.70
	800/200	1.4301	9.5	240	270	100	820	250	2.0	5.70
	1.00/200	1.4301	9.3	240	270	100	1,020	400	2.0	6.90
	630/300	1.4301	14.5	340	270	100	650	80	2.0	6.65
	800/300	1.4301	16.5	360	295	125	820	250	2.0	9.10
	1,100/300	1.4301	14.2	360	270	100	1,120	500	2.0	10.60
	630/400	1.4301	17.3	440	270	100	650	80	2.0	8.70
KF 24 /	800/400	1.4301	25.0	440	320	150	820	250	2.0	12.10
	1,800/200	1.4301	10.8	260	376	120	1,630	880	2.5	17.80
	2,000/300	1.4301	19.4	360	403	150	2,030	1,170	2.5	30.00
KF 0.5 /	1,400/400	1.4301	41.5	660	416	160	1,430	688	2.5	35.80
	350/ 13	1.4301	0.1	45	115	25	350	125	1.0	0.50
	275/ 50	1.4301	0.8	80	130	40	290	65	1.0	0.50
KF 0.7 /	400/ 50	1.4301	0.7	80	130	40	415	145	1.0	0.60
	630/ 50	1.4301	0.7	80	155	40	645	250	1.5	1.50
	400/100	1.4301	2.2	130	175	60	415	50	1.5	1.40
KF 0.9 /	500/100	1.4301	2.8	130	205	60	515	90	1.5	2.00
	800/100	1.4301	2.7	130	205	60	815	350	1.5	2.80
	700/150	1.4301	4.1	180	205	60	715	250	1.5	3.00

Compact feeders with storage containers

ALL-ROUNDERS THAT JUST KEEP GIVING

Main measurements

Type	Suitable for compact feeders	Material Storage container and base	Container capacity [dm ³]	Dimensions [mm]						Weight of storage container with base kg		
				a	b	c	d	Øf	Øg		h	Øl
KF 1 /.../...		Stainless	9	120	150	480	520	43	300	620	7	8.5
			25	180	200	480	520	90	400	730	7	11.5
KF 6 /.../...		Stainless	25	180	200	530	570	90	400	765	7	12.0
KF 12 /.../...		Stainless	50	230	260	600	640	159	510	940	9	28.0
KF 0.5 /.../...		Stainless	9	120	150	390	430	43	300	580	7	8.0
KF 0.7 /.../...		Stainless	9	120	150	480	520	43	300	580	7	8.5
			25	180	200	480	520	90	400	730	7	11.5
KF 0.9 /.../...		Stainless	25	180	200	560	600	90	400	765	7	12.0

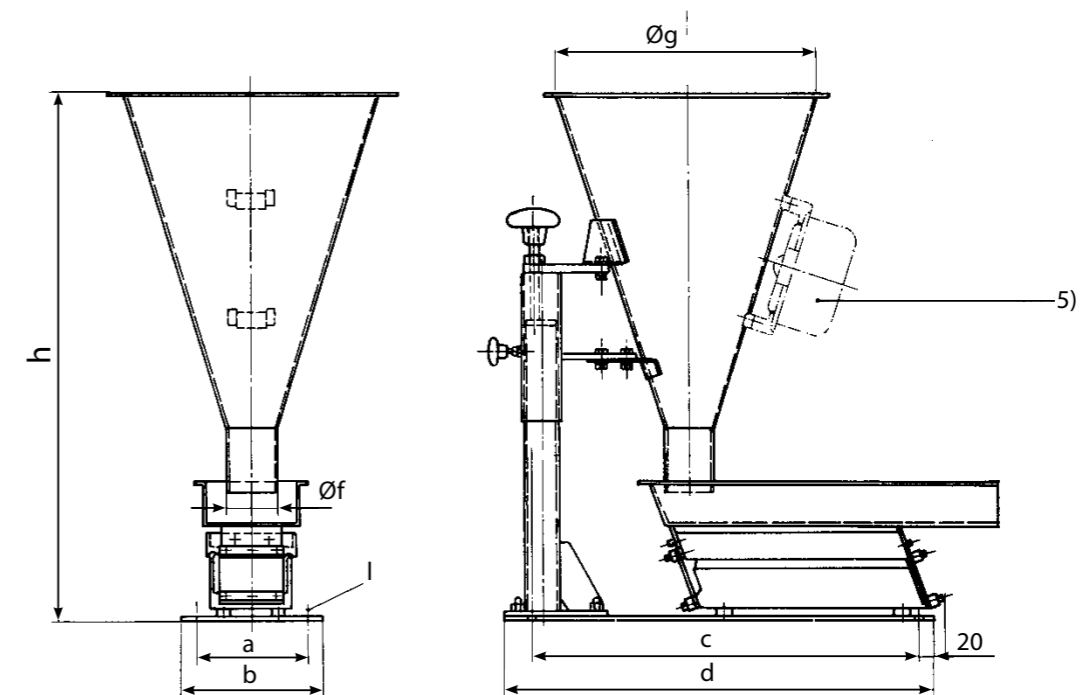

Controllers – magnetic technology

INTELLIGENT CLOCKS

AVITEQ provides separate controllers for its compact feeders. The controllers are suitable for 50 or 60 Hz alternating current networks. The modern, electronic controllers in the SRA and SC series are thyristor controllers. Using their standard functions and their additional, customisable options, they can be adapted to suit application-specific requirements. Alternatively, a frequency controller from the SFA series can be chosen. These controllers score highly because they offer a wide variety of options.

Benefits

Thyristor:

- Device-specific tuning
- Not susceptible to bunker pressure
- Simple and straightforward
- Robust and not vulnerable, even in challenging environments

Frequency controllers:

- Convenient, user-friendly calibration and tuning
- Ideal for multiple drives and synchronising multiple drives
- Perfect if troughs and uses are varied



TECHNICAL CHARACTERISTICS

	SRA	SRA(E)	SC	SC(E)	SFA	SFA(E)
Vibrator current, maximum	6 A	6 A	15 A	15 A	8 A	8 A
Controller type	Thyristor	Thyristor	Thyristor	Thyristor	Frequency	Frequency
Mains voltage in 50/60 Hz networks Special voltages available on request	105...115 V 220...240 V	105...115 V 220...240 V	220...240 V 380...420 V 440...480 V 500...520 V	220...240 V 380...420 V 440...480 V 500...520 V	Input voltage: 105 - 115 V or 220 -240 V Output voltage: 0 - 102 V or 0 - 205 V	Input voltage: 105 - 115 V or 220 -240 V Output voltage: 0 - 102 V or 0 - 205 V
Vibration frequency in 50 Hz network	50 or 100 Hz	50 or 100 Hz	25 or 50 Hz	25 or 50 Hz	5...300 Hz	5...300 Hz
Vibration frequency in 60 Hz network	60 or 120 Hz	60 or 120 Hz	30 or 60 Hz	30 or 60 Hz	30, 40 or 60 Hz	30, 40 or 60 Hz
Signal processing	analogue	analogue	analogue	analogue	analogue	analogue
Voltage control	+	+	+	+	+	+
External reference variables directly connectable (0-10 VDC, 4-20 mA and 0-20 mA)	+	+	+	+	+	+
Set value switchable between potentiometer (local) and external reference variable	(+) ¹	(+) ¹	+	+	+	+
Open frame version (E), Height x width x depth [mm]	170 x 120 x 92	125 x 112 x 102	300 x 300 x 210	200 x 62 x 190	205 x 100 x 208	205 x 100 x 192

+ = integrated ¹Only possible at 0-10 V DC.



Made by AViTEQ IN DEMAND WORLDWIDE



We are there for you, around the world, and in over 30 countries locally. Talk to us, become a customer, and find out exactly what quality and service Made by AViTEQ means. We always keep our contact information up-to-date for you at:

● www.aviteq.com ●

AViTEQ
Vibrationstechnik GmbH

AViTEQ Vibrationstechnik GmbH

Im Gotthelf 16
D-65795 Hattersheim

Tel.: +49 (0) 6145 503-0
Fax: +49 (0) 6145 503-200
E-mail: info@aviteq.de
www.aviteq.com/en/